

**SINGAPORE CHINESE GIRLS' SCHOOL**  
**SECOND SEMESTRAL ASSESSMENT 2015**

**PRIMARY 5**  
**MATHEMATICS**  
**PAPER 1**  
**BOOKLET A**

Name : \_\_\_\_\_ (    )

Class : Primary 5

|             |           | Marks attained | Max Mark |
|-------------|-----------|----------------|----------|
| Paper 1     | Booklet A |                | 20       |
|             | Booklet B |                | 20       |
| Paper 2     |           |                | 60       |
| Total Marks |           |                | 100      |

| Parent's Signature |
|--------------------|
|                    |

15 Questions  
20 Marks

Total Time for Booklets A and B: 50 min

**INSTRUCTIONS TO CANDIDATES**

Do not open this booklet until you are told to do so.  
Follow all instructions carefully.  
Answer all questions.  
You are not allowed to use a calculator



**Booklet A**

Questions 1 to 10 carry 1 mark each. Questions 11 to 15 carry 2 marks each.  
For each question, four options are given. One of them is the correct answer.  
Make your choice (1, 2, 3 or 4). Shade the correct oval (1, 2, 3 or 4) on the Optical Answer Sheet. (20 marks)

---

1. 701 936 is 50 000 less than \_\_\_\_\_.

- (1) 651 936
- (2) 696 936
- (3) 706 936
- (4) 751 936

2. Which of the following numbers when rounded off to the nearest thousand is 170 000?

- (1) 169 499
- (2) 169 501
- (3) 170 549
- (4) 170 905

3. 40% of a number is 50. What is the number?

- (1) 20
- (2) 25
- (3) 100
- (4) 125

4. In the figure below, ABCD is a square. Point E is the midpoint of AC. What fraction of the square is shaded?

- (1)  $\frac{1}{6}$
- (2)  $\frac{1}{2}$
- (3)  $\frac{1}{3}$
- (4)  $\frac{1}{4}$

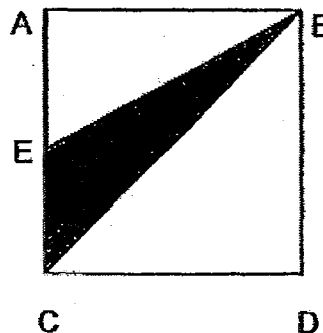

5.  $72 \div 1000 =$  \_\_\_\_\_

- (1) 0.072
- (2) 0.720
- (3) 7200
- (4) 72 000

6. John lost 30 marks in an English test. He scored 90 marks. What percentage did he score for the test?

- (1) 20%
- (2) 25%
- (3) 75%
- (4) 80%

7. Mrs Li mixed butter and sugar to make a butter cake.  $\frac{4}{5}$  of this mixture consists of butter. She used 500 g of butter. How much sugar did she use?

- (1) 100 g
- (2) 125 g
- (3) 600 g
- (4) 625 g

8. The ratio of the length of a rectangle to its breadth is 7:3. The length is 21 cm. What is the perimeter of the rectangle?

- (1) 30 cm
- (2) 60 cm
- (3) 300 cm
- (4) 600 cm

9. Alan took the train from City Hall MRT station to Changi Airport. The journey took 27 minutes. He reached Changi Airport at 10.23 a.m. What time did he board the train at City Hall?

- (1) 9.27 a.m.
- (2) 9.56 a.m.
- (3) 10.04 a.m.
- (4) 10.50 a.m.

10. The triangle below is not drawn to scale. D is the mid-point of AB.  
AD = 5 cm, ~~BC = 8 cm~~, ~~AE = 10 cm~~ and ~~DC = 8 cm~~. Find the area of the triangle ABC.

$DC = 8 \text{ cm}$

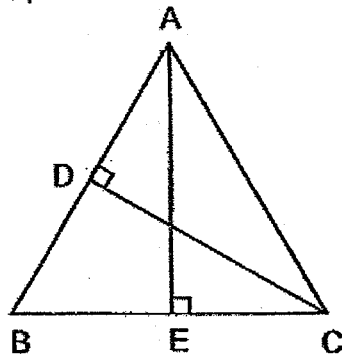

- (1)  $16 \text{ cm}^2$   
(2)  $20 \text{ cm}^2$   
(3)  $32 \text{ cm}^2$   
(4)  $40 \text{ cm}^2$
11. Find the value of  $5 \times 4 - (9 + 2) + 6 + 3$ .
- (1) 5  
(2) 7  
(3) 11  
(4) 15
12. There were 600 more boys than girls in a school. 60% of the pupils were boys. How many girls were there in the school?
- (1) 400  
(2) 1200  
(3) 1800  
(4) 3000

13. The ratio of Mrs Toh's age to Molly's age is 17 : 5 now. Mrs Toh is 24 years older than Molly.  
Find the ratio of Mrs Toh's age to Molly's age 4 years ago.

- (1) 3 : 1
- (2) 4 : 1
- (3) 5 : 1
- (4) 19 : 7

14. The figure below is not drawn to scale. ABCD and PQRS are 2 overlapping squares.  
 $\angle SRC = 60^\circ$ . Find  $\angle QRB$ .

- (1)  $30^\circ$
- (2)  $60^\circ$
- (3)  $90^\circ$
- (4)  $150^\circ$

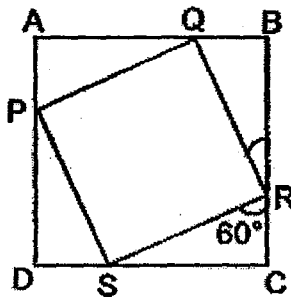

15. Study the graph below.

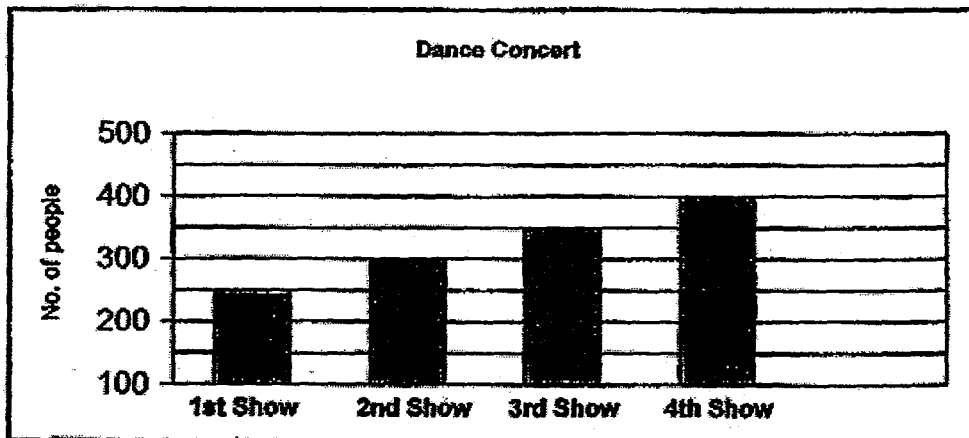

What is the average number of people who attended the 3<sup>rd</sup> and 4<sup>th</sup> shows of the Dance Concert?

- (1) 275
- (2) 325
- (3) 375
- (4) 750

**SINGAPORE CHINESE GIRLS' SCHOOL**  
**SECOND SEMESTRAL ASSESSMENT 2015**

**PRIMARY 5**

**MATHEMATICS**  
**PAPER 1**

**BOOKLET B**

Name : \_\_\_\_\_ (     )

Class : Primary 5

| Paper 1   | Mark attained | Max Mark |
|-----------|---------------|----------|
| Booklet B |               | 20       |

**15 Questions**  
**20 Marks**

**Total Time for Booklets A and B: 50 min**

**INSTRUCTIONS TO CANDIDATES**

Do not open this booklet until you are told to do so.

Follow all instructions carefully.

Answer all questions.

You are not allowed to use a calculator





**Booklet B**

Name: \_\_\_\_\_ ( ) Class: P5 SY / C / G / SE / P

Do not write  
in this  
column

Questions 16 to 25 carry 1 mark each. Write your answers in the spaces provided.  
For questions which require units, give your answers in the units stated. (10 marks)

---

16. Which of the following has the largest value?

Ans: \_\_\_\_\_

---

17. How many tenths are there in 3.8?

Ans: \_\_\_\_\_

---

18. Express  $\frac{1}{20}$  as a decimal.

Ans: \_\_\_\_\_

---

19. In  $18 : 48 = 27 : \underline{\hspace{2cm}}$ , what is the missing number?

Ans: \_\_\_\_\_

---

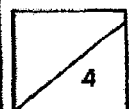

20. 1 kg 80 g = \_\_\_\_\_ kg

Do not write  
this column

Ans: \_\_\_\_\_ kg

21. What is the area of the shaded triangle ABD?

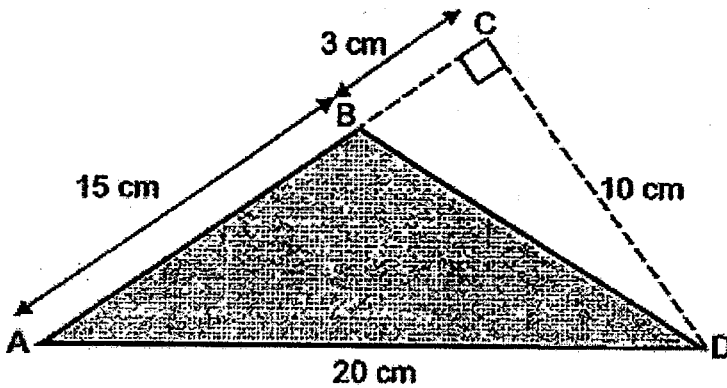

Ans: \_\_\_\_\_ cm<sup>2</sup>

22. Arrange these numbers to form the smallest 5-digit even number.



Ans: \_\_\_\_\_

23. A tank, measuring 50 cm long, 10 cm wide and 15 cm high, was  $\frac{2}{5}$  filled with water. How much more water is needed to fill the tank to its brim?

Ans: \_\_\_\_\_ cm<sup>3</sup>



24. The figure below is not drawn to scale.  
AC is a straight line.  
Find  $\angle ABE$ .

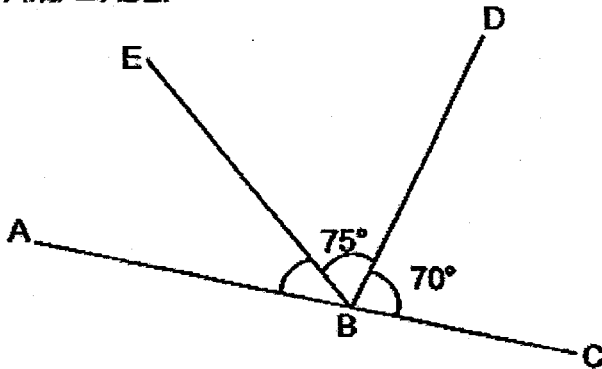

Ans: \_\_\_\_\_<sup>o</sup>

25. The line graph below shows the growth of a plant in weeks.

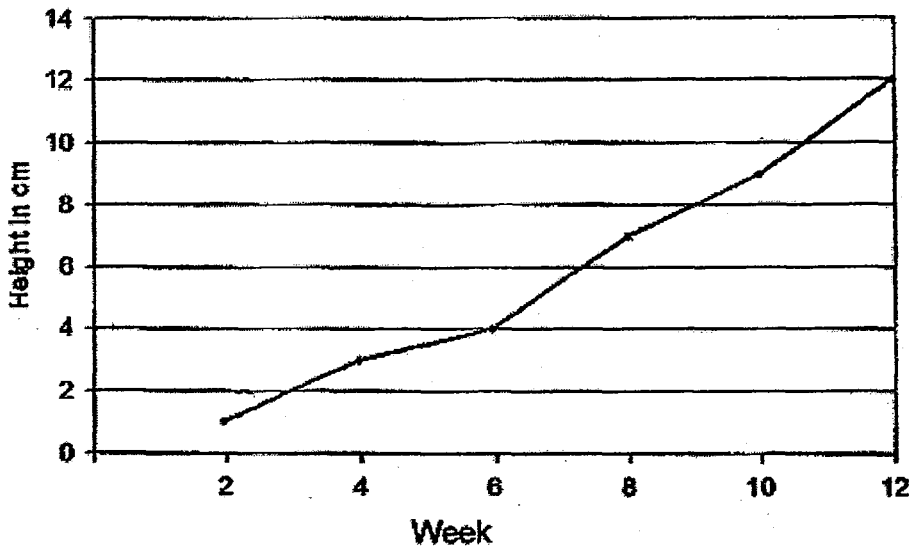

During which period was the plant's growth the slowest?

Ans: Between Week \_\_\_ to Week \_\_\_

Questions 26 to 30 carry 2 marks each. Show your working clearly in the space for each question and write your answers in the spaces provided.  
For questions which require units, give your answers in the units stated. (10 marks)

Do not write in  
this column

26. Molly, Nathan and Oliver sold booklets of tickets for the school fun fair. Molly and Nathan sold a total of 50 booklets. Nathan and Oliver sold a total of 20 booklets. Molly sold three times as many booklets as Oliver. How many booklets did Oliver sell?

Ans: \_\_\_\_\_

27. Mr Toh sold  $\frac{1}{3}$  of his rice on Monday,  $\frac{2}{5}$  kg on Tuesday and had 16 kg left.  
How much rice did he have at first?

Ans: \_\_\_\_\_ kg

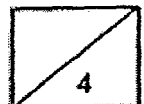

Do not write in  
this column

28. What is the maximum number of 2-cm cubes that can be placed into the container shown below?

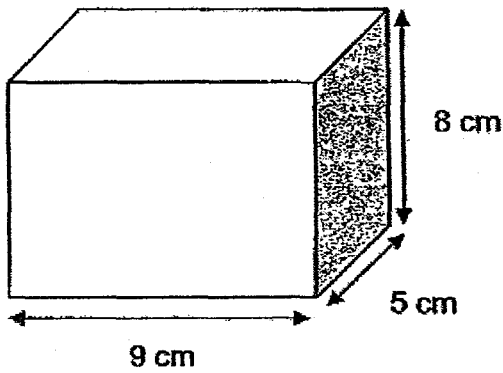

Ans: \_\_\_\_\_

29. The figure below is not drawn to scale. AB and CD are straight lines.  
Find  $\angle k$ .

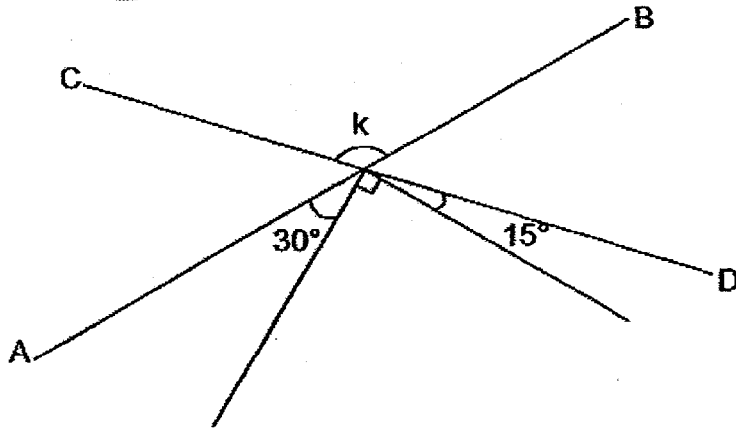

Ans: \_\_\_\_\_°

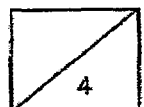

30. Kelly spent  $\frac{7}{10}$  of her money on 15 kiwis and 5 apples.

A kiwi costs twice as much as an apple, how many apples can Kelly buy with the rest of her money?

Ans: \_\_\_\_\_

---

End of paper  
- Check your work thoroughly -

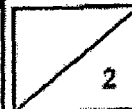

**SINGAPORE CHINESE GIRLS' SCHOOL**  
**SECOND SEMESTRAL ASSESSMENT 2015**

**PRIMARY 5**  
**MATHEMATICS**

**PAPER 2**

Name : \_\_\_\_\_ (     )

Class : Primary 5

|                | Mark | Max Mark  |
|----------------|------|-----------|
| <b>Paper 2</b> |      | <b>60</b> |

| Parent's Signature |
|--------------------|
|                    |

**18 Questions**  
**60 Marks**

**Total Time For Paper 2: 1 h 40 min**

**INSTRUCTIONS TO CANDIDATES**

Do not open this booklet until you are told to do so.  
Follow all instructions carefully.  
Answer all questions.





Name: \_\_\_\_\_ ( ) Date: \_\_\_\_\_  
Class: Primary 5

Do not write in  
this column

Questions 1 to 5 carry 2 marks each. Show your working clearly in the space below each question and write your answers in the space provided. For questions which require units, give your answers in the units stated.

(10 marks)

1. The advertisement below shows a promotion offered by Hotel Loyal during the December holidays.

|                             |
|-----------------------------|
| <b>Hotel Loyal</b>          |
| Stay one night \$260        |
| Stay 3 nights, 1 night free |

Mr Tan and his family stayed 5 nights in the hotel.  
How much did they pay?

Ans: \$ \_\_\_\_\_

2. The graph below shows the amount of money 5 boys saved in a week but the amount of money Edward saved was not drawn in.

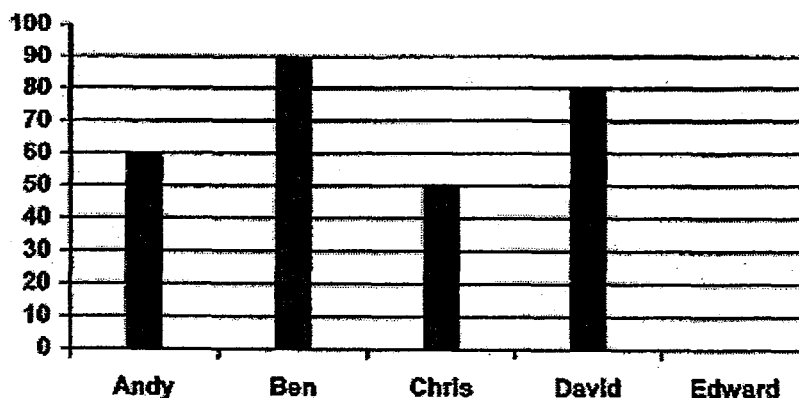

The average amount saved was \$60.  
How much did Edward save?

Ans: \$ \_\_\_\_\_

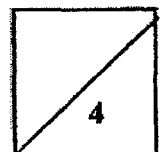

3. Mrs Toh had 120 apples and 150 oranges. She sold  $\frac{1}{4}$  of the apples and  $\frac{1}{5}$  of the oranges. How many fruits were left?

Do not write in  
this column

Ans: \_\_\_\_\_

4. The figure below is not drawn to scale. MN, OP and QR are straight lines. Find  $\angle a$ .

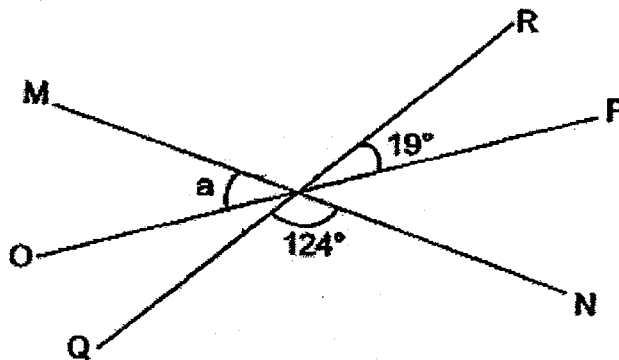

Ans: \_\_\_\_\_

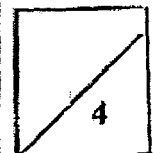

Do not write in  
this column

5. Four square cards are arranged as shown in the figure below.

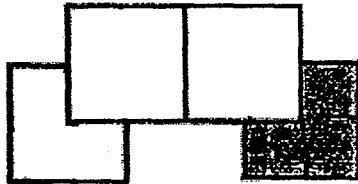

Each card overlaps another card by  $\frac{1}{4}$  of its area.

What percentage of the figure is shaded?  
(Round off your answer to 1 decimal place).

Ans: \_\_\_\_\_ %

---

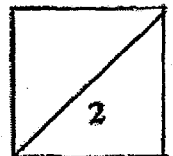

For questions 6 to 18, show your working clearly in the space below each question and write your answers in the spaces provided. The number of marks awarded is shown in brackets [ ] at the end of each question or part-question.

Do not write  
this column

(50 marks)

6. The ratio of the number of pupils in Class A to the number of pupils in Class B was 4 : 9. The number of pupils in Class B is thrice the number of pupils in Class C. There were 9 pupils more in Class A than in Class C. How many pupils were there in the 3 classes?

Ans: \_\_\_\_\_ [3]

7. A basin was  $\frac{1}{4}$  filled with water. When 350 ml of water was added, it became  $\frac{3}{5}$  full. What was the capacity of the basin? (Give your answer in ml)

Ans: \_\_\_\_\_ [3]

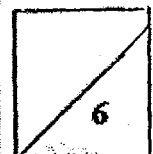

8. Alan had \$16 more than Bob. After Bob had given Alan \$7, Alan had thrice as much as Bob. How much did Alan have at first?

Do not write in  
this column

Ans: \_\_\_\_\_ [ 3 ]

---

9. The average number of pupils in School A, B, and C was 800. There were 200 more pupils in School A than in School B. The number of pupils in School C was twice as many as the number of pupils in School A. How many pupils were there in School B?

Ans: \_\_\_\_\_ [ 3 ]

---

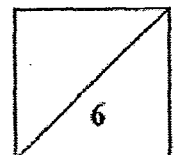

10. a) Sally is facing East at first. She makes a  $\frac{3}{4}$  clockwise turn and then another  $225^\circ$  anti-clockwise turn. Where will she be facing at last?

Do not write in this column

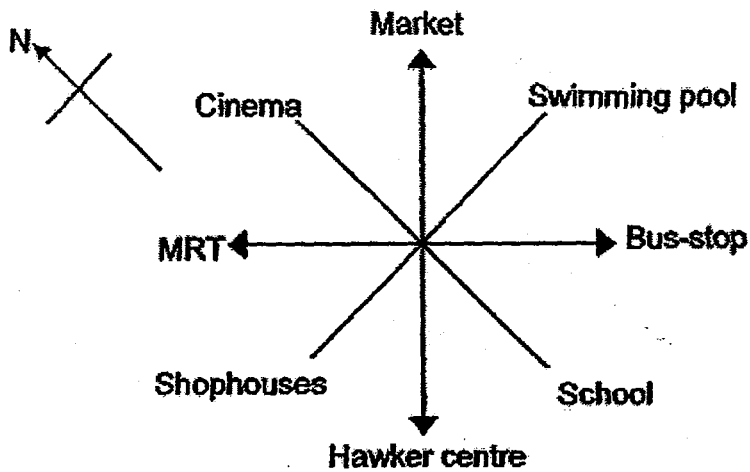

- b) A rectangular piece of paper is folded along the dotted line as shown below. Find  $\angle w$ .

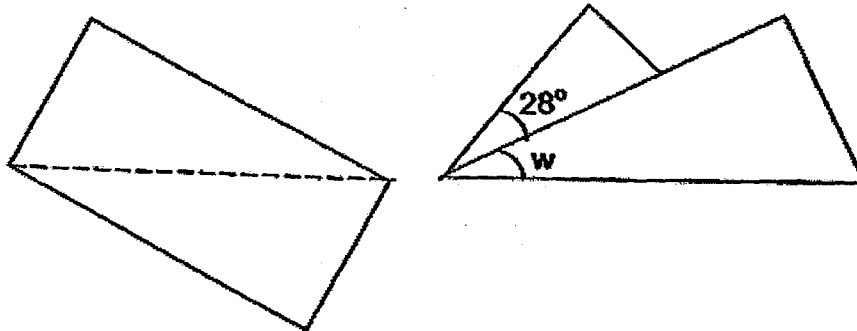

Ans: a) \_\_\_\_\_ [1]

b) \_\_\_\_\_ [2]

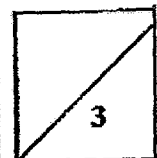

Do not write in  
this column

11.  $\frac{3}{4}$  of Cindy's money is equal to  $\frac{1}{2}$  of Annie's money.  $\frac{3}{10}$  of Cindy's money is equal to  $\frac{2}{5}$  of Rita's money.

If Annie had \$48 more than Rita, how much money did the 3 girls have altogether?

Ans: \_\_\_\_\_ [4]

---

12. Andrea sold some mangoes at \$3 each and some pineapples at \$7 each. A total of 61 fruits were sold. She collected \$327 from the sale of the fruits. How many mangoes did she sell?

Ans: \_\_\_\_\_ [4]

---

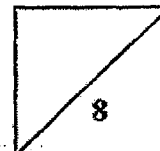

13. Sam had 88 more muffins than Julia. He gave 20% of his muffins to Julia. He then had twice as many muffins as Julia.  
How many muffins did Sam have at first?

Do not write in  
this column

Ans: \_\_\_\_\_ [ 4 ]

---

14. 58% of the fruits in a box were apples.  $\frac{5}{6}$  of the remainder were pears and the rest were peaches. There were 140 more pears than peaches.  
How many fruits were there in the box?

Ans: \_\_\_\_\_ [ 4 ]

---

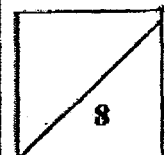



15. Tank A contained some water and Tank B was empty. Some of the water was poured from Tank A to Tank B. 600 ml of the water was spilt. The height of the water level in Tank A became 10 cm. The height of the water level in Tank B became 12 cm.

Do not write in this column

What was the height of the water level in Tank A at first?

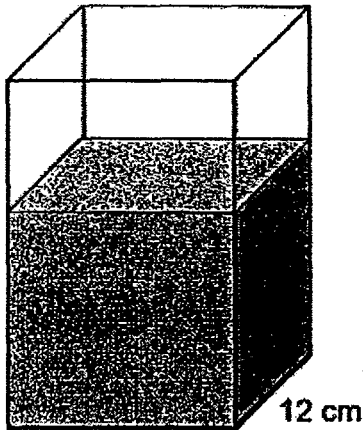

40 cm

Tank A

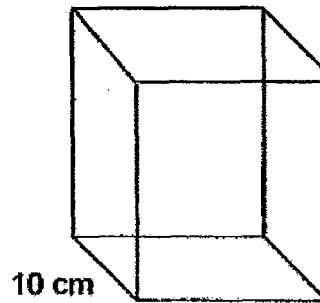

30 cm

Tank B (empty)

Ans: \_\_\_\_\_ [ 4 ]

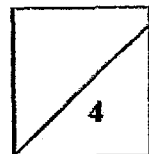

16. Mr Toh wants to make 25 small bows and 22 big bows. The length of ribbon used to make 6 big bows is the same as 8 small bows. He managed to make 10 big bows and 16 small bows with 1320 cm of ribbon.

Do not write in  
this column

(a) How many small bows can he make with the same length of ribbon needed to make 12 big bows?

(b) What is the length of wire needed to make the remaining bows?  
ribbon

Ans: (a) \_\_\_\_\_ [ 1 ]

(b) \_\_\_\_\_ [ 4 ]

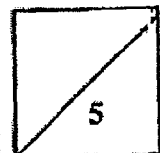

17. All the tickets for a concert were sold out. For every 9 tickets of Category A sold, 5 tickets and 3 tickets were also sold for Categories B and C respectively. The difference in the amount collected from the sale of tickets between Categories B and C was \$6900.

Do not write in  
this column

How many people attended the concert?

| Category | Cost  |
|----------|-------|
| A        | \$88  |
| B        | \$128 |
| C        | \$198 |

Ans: \_\_\_\_\_ [5]

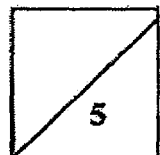

18. The figure below was formed by 9 identical right-angled triangles. The perimeter of the figure was 72 cm. The shortest side of each triangle, AB, was 6 cm.

Do not write in this column.

- a) Find the perimeter of each triangle.
  - b) The longest side of the each triangle is 4 cm shorter than the sum of the other 2 sides.
- Find the area of the figure.

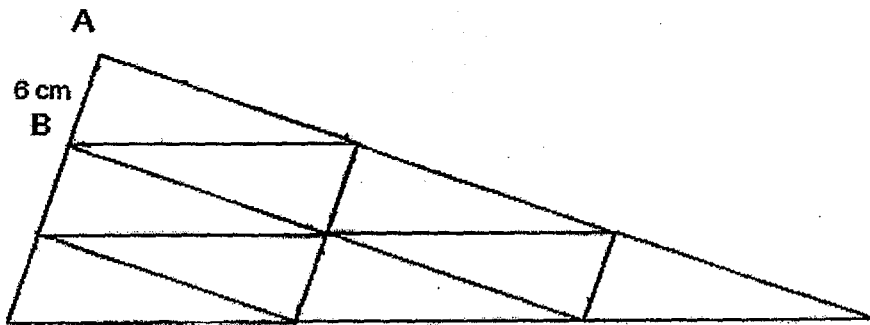

Ans: a) \_\_\_\_\_ [2]

b) \_\_\_\_\_ [3]

End of Paper  
- Check your work thoroughly -

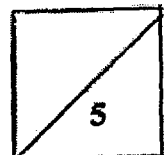

SINGAPORE CHINESE GIRLS' SCHOOL  
SECOND SEMESTRAL ASSESSMENT 2015  
PRIMARY 5 MATHEMATICS  
PAPER 1

- 1) 4      2) 2      3) 4      4) 4      5) 1      6) 3      7) 2      8) 2      9) 2  
10) 4     11) 3     12) 2     13) 3     14) 1     15) 3

16) 0.71

17)  $3.8 \div 1/10 = 38$  tenths

18) 0.05

19)  $18:48 = 9:24 = 27:\underline{72}$

20) 1.08 kg

21)  $1/2 \times 15 \times 10 = 75$  sq cm

22) 12374

23)  $3/5 \times 50 \times 10 \times 15 = 4500$  cubic cm

24)  $180^\circ - 70^\circ - 75^\circ = 35^\circ$

25) Between Week 4 to Week 6

26)  $M+N = 50$

$O+N = 20$

Difference,  $M-O = 50-20 = 30$

$30-10 = 30$

$10 = 30 \div 2 = 15$  booklets sold

27)  $2u - 16 + 2/5 = 16/2/5$  kg

$3u - 3/2 \times 16/2/5 = 24.6$  kg at first

28)  $8 \div 2 = 4$

$5 \div 2 = 2$  R1

$9 \div 2 = 4$  R1

$4 \times 2 \times 4 = 32$  cubes

29)  $30^\circ + 90^\circ + 15^\circ = 135^\circ$

30)  $7u - (30+5)$  apples = 35 apples

$3u - 3/7 \times 35 = 15$  apples

## PAPER 2

1)  $\$260 \times 4 = \$1040$

2)  $\$60 \times 5 = \$300$   
 $\$(300-280) = \$20$

3)  $3/4 \times 120 = 90$   
 $4/5 \times 150 = 120$   
 $90 + 120 = 210$  fruits

4)  $180^\circ - 124^\circ - 19^\circ = 37^\circ$

5)  $3/14 \times 100\% \approx 21.4\%$

6) A:B:C = 4:9:3  
 $1u = 9$   
 $16u = 16 \times 9 = 144$  pupils

7)  $3/5 - 1/4 = 7/20$   
 $7u = 350$  ml  
 $20u = 20/7 \times 350 = 1000$  ml

8)  $2u = \$(16+14) = \$30$   
 $3u = 3/2 \times \$30 = \$45$   
 $\$(45-7) = \$38$

9)  $800 \times 3 = 2400$   
 $2400 - 600 = 1800$   
 $1800 \div 4 = 450$  pupils in School B

10a) Bus-stop  
b)  $(90-28) \div 2 = 31^\circ$

11) Cindy --  $3/4 = 15/20$ , Annie --  $1/2 = 15/30$   
Cindy --  $3/10 = 6/20$ , Rita --  $2/5 = 6/15$   
 $20u + 30u + 15u = 65u$   
 $15u = \$48$   
 $65u = 65/15 \times \$48 = \$208$

12) Assume all the fruits sold were pineapples,  
 $61 \times \$7 = \$427$   
 $\$(427-327) = \$100$   
 $7-3 = 4$   
 $100 \div 4 = 25$  mangoes

13) S : J  
original 100 : 20  
new 80 : 40  
 $8u = 88$  muffins  
 $10u = 10/8 \times 88 = 110$  muffins

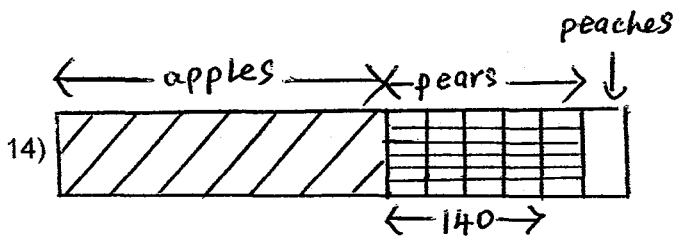

$$4u = 140$$

$$6u = 6/4 \times 140 = 210$$

$$42\% = 210$$

$$100\% = 10/42 \times 210 = 500 \text{ fruits in the box}$$

15)  $30 \times 10 \times 12 = 3600$  cubic cm

$$(3600 + 600) \text{ cm} = 4200 \text{ cubic cm}$$

$$4200 \div 40 \div 12 = 8.75 \text{ cm}$$

$$(10 + 8.75) \text{ cm} = 18.75 \text{ cm}$$

16)  $6B = 8S$

$$12B = 2 \times 8S = 16S$$

a) Ans: 16 small bows

$$12B + 9S = 16S + 9S = 25S$$

$$10B + 12B = 1320$$

$$22B = 1320 \text{ cm}$$

$$10B = 10/22 \times 1320 = 600 \text{ cm}$$

$$(1320 - 600) \text{ cm} = 720 \text{ cm}$$

$$16S = 720 \text{ cm}$$

b)  $25S = 25/16 \times 720 = 1125 \text{ cm}$

17)  $\$128 \times 5 = \$640$

$$\$198 \times 3 = \$594$$

$$\$(640 - 594) = \$46$$

$$\$(6900 \div 46) = 150$$

$$9 + 5 + 3 = 17$$

$$150 \times 17 = 2550 \text{ people attended the concert}$$

18a) Perimeter of each triangle =  $72 \text{ cm} \div 3 = 24 \text{ cm}$

b)  $24 - 4 = 20$

$$20 \div 2 = 10$$

$$24 - 10 - 6 = 8$$

$$1/2 \times 6 \times 8 \times 9 = 216 \text{ sq cm}$$

